

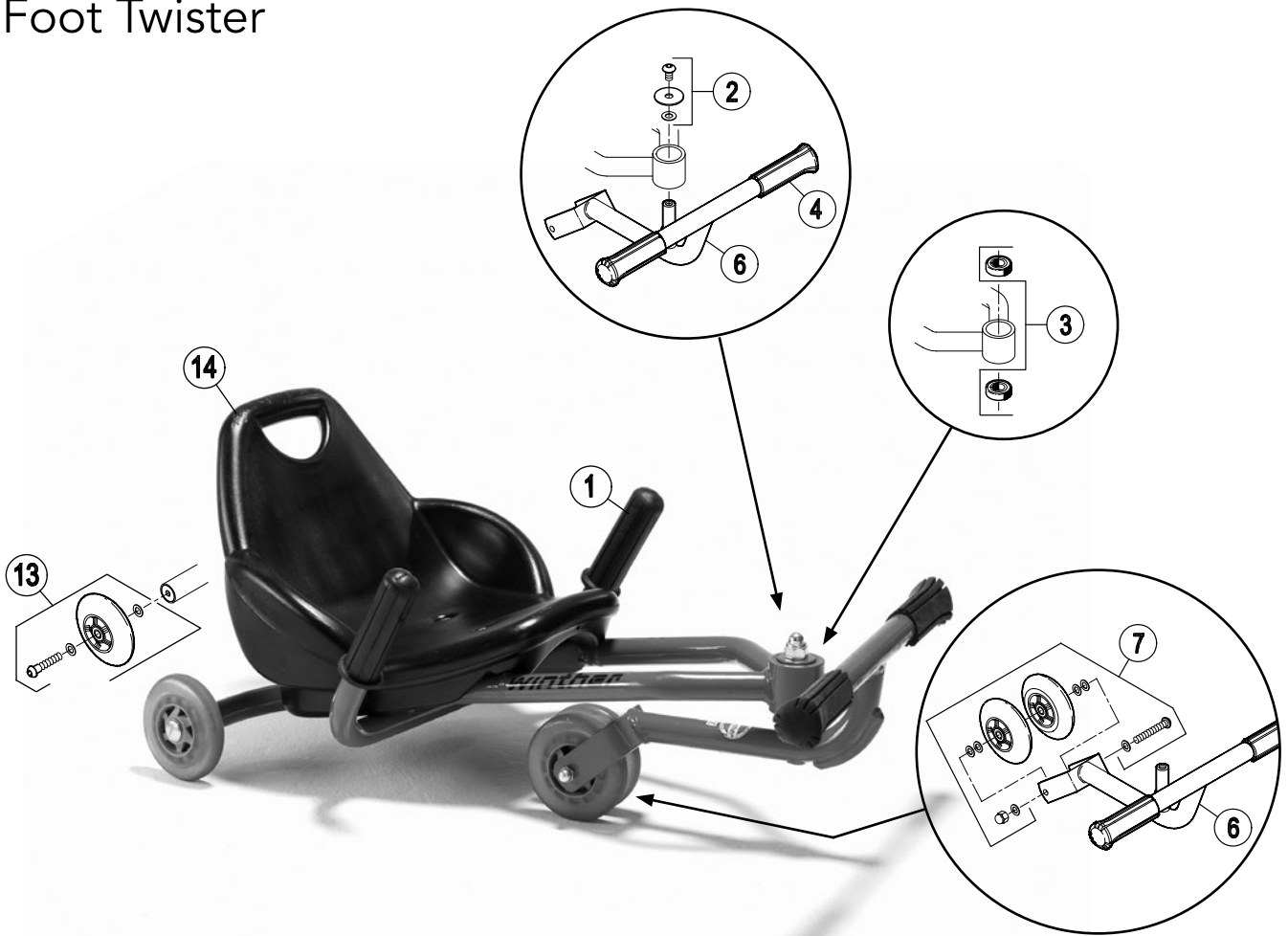













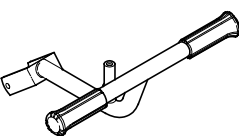



























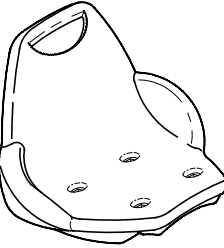

Ersatzteile für:
112147
Foot Twister



Pos.		Pos.	
1	 x2	8	
2	 x1  x1  x1	9	
3	 x2	10	
4	 x2	11	
5		12	
6	     	7	           
13	          	14	         

Ersatzteile für:
112147
Foot Twister

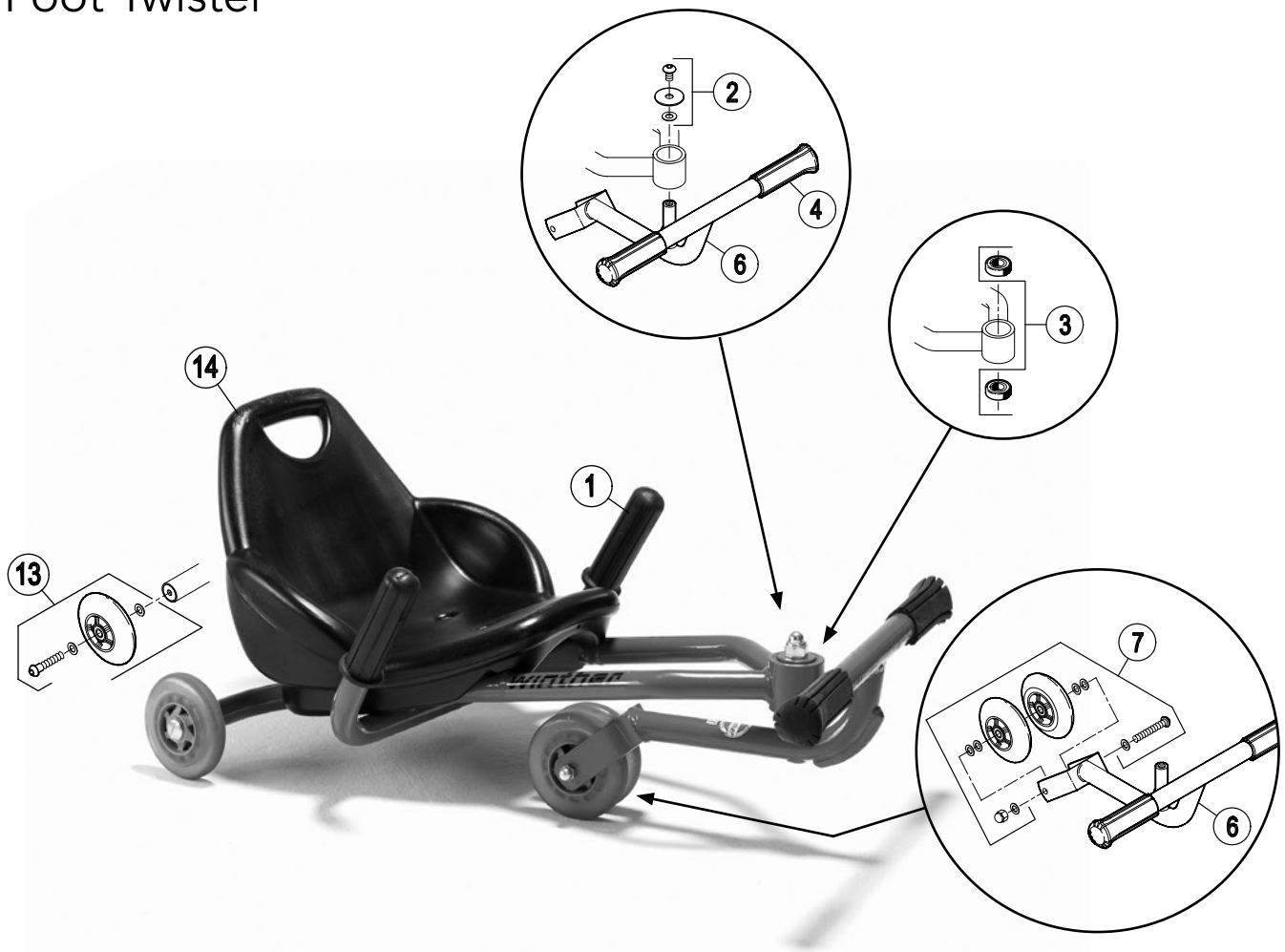

	62000								
	Version								
Pos.	1.0								
1	50403								
2	50488								
3	50489								
4	50902								
5	-								
6	50490								
7	50491								
8	-								
9	-								
10	-								
11	-								
12	-								
13	50492								
14	50493								
15	-								
16	-								
17	-								
18	-								