

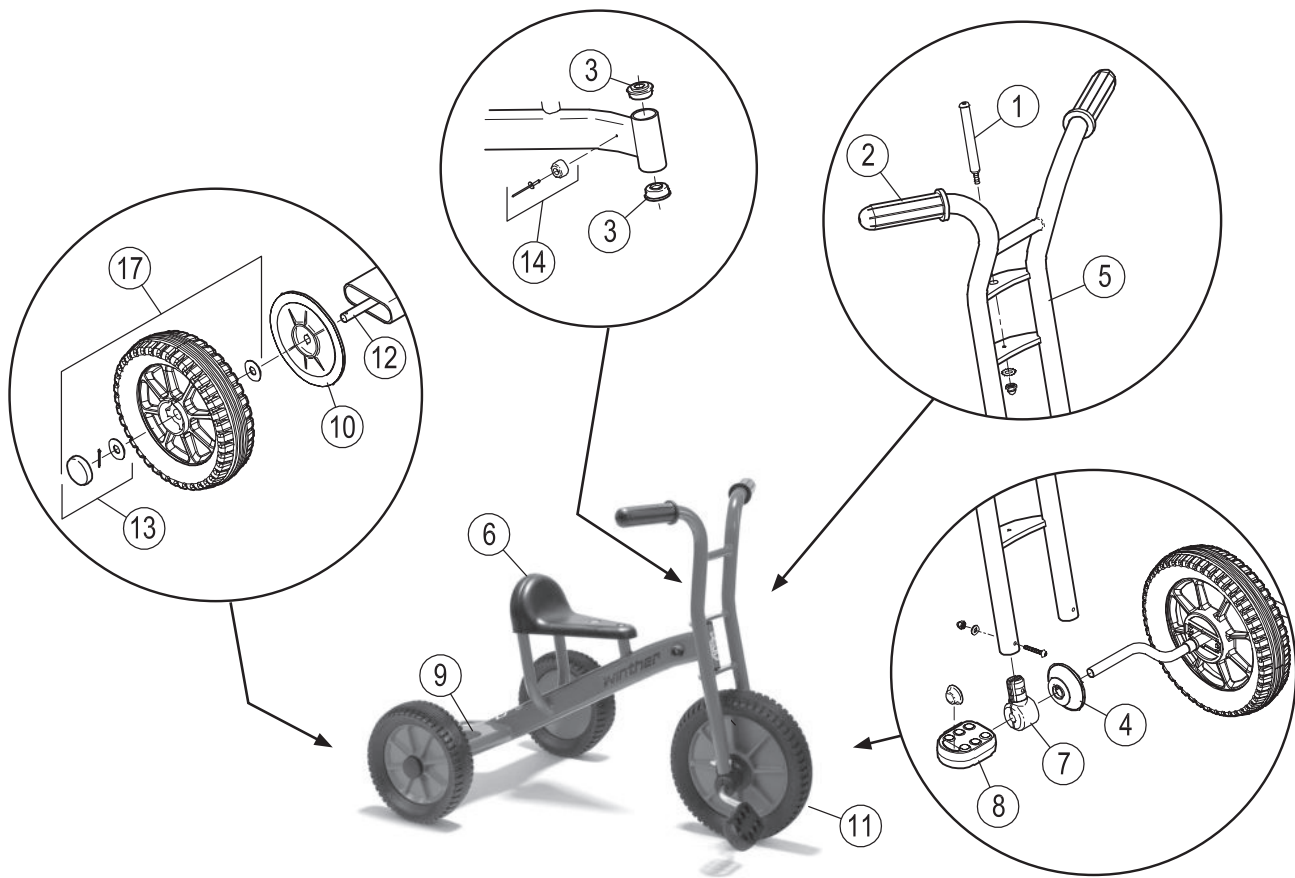





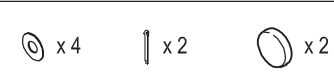
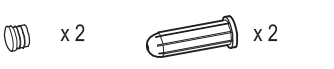

Ersatzteile für:

112125

VIKING Dreirad mittel

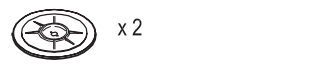
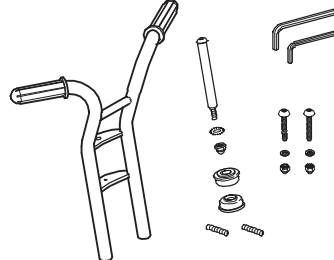
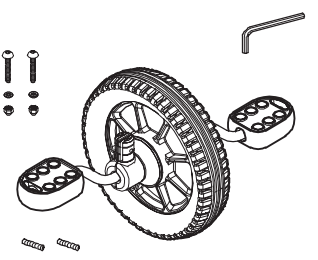
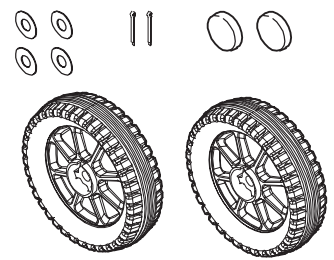
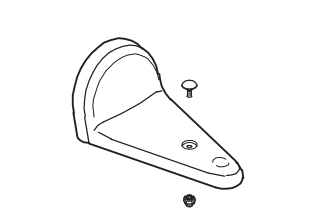
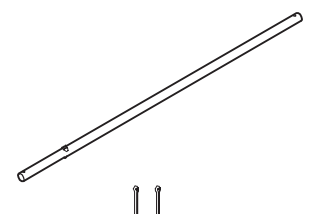

Pos.		Pos.		Pos.	
1	 x1 x2 x1	7	 x2 x2 x2 x1	13	 x4 x2 x2
2	 x2 x2	8	 x2 x2	14	 x2 x2
3	 x2	9	 x2	15	
4	 x2	10	 x2	16	
5		11		17	
6		12		18	

Ersatzteile für:

112125

VIKING Dreirad mittel

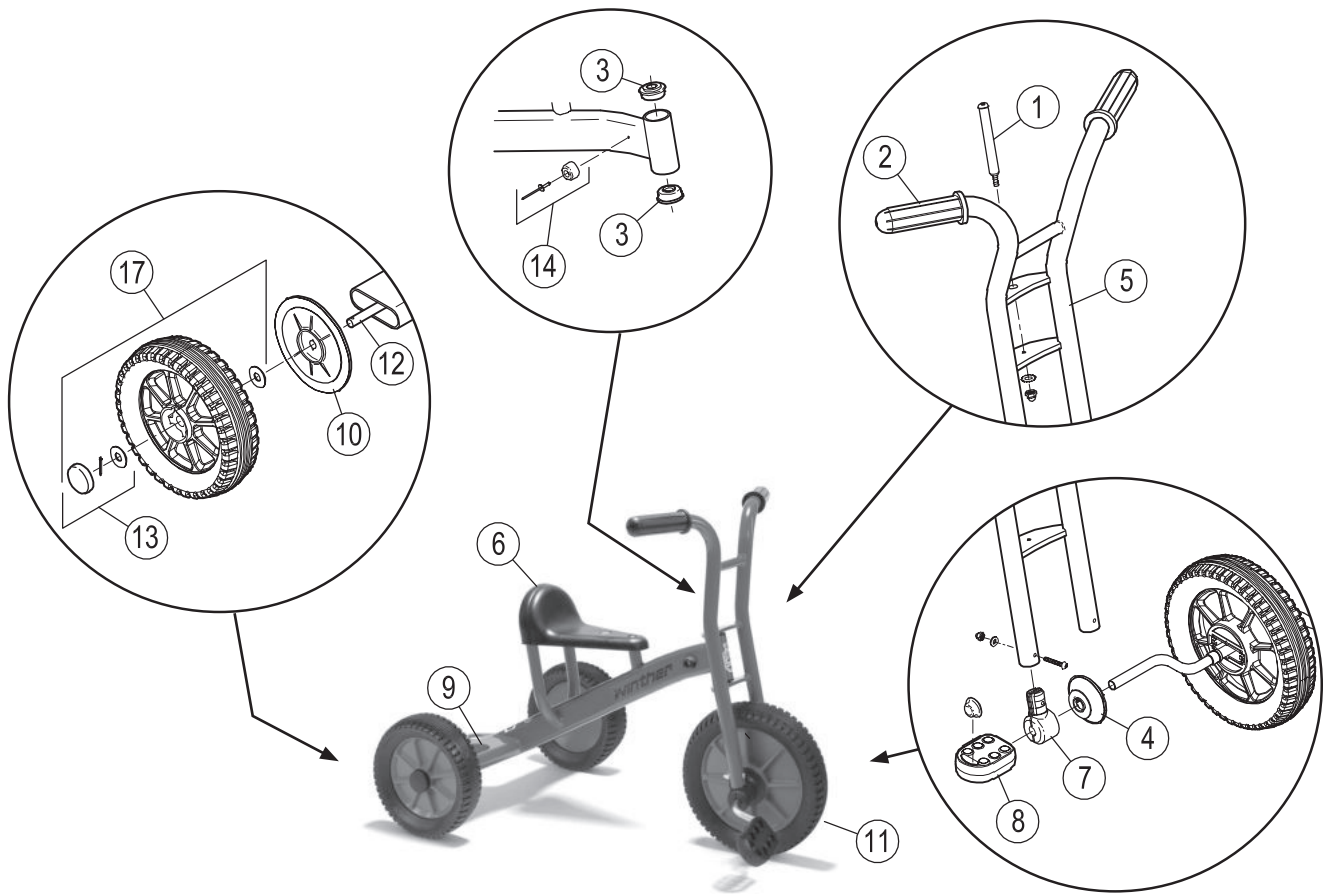

	451.00			
	Version			
Pos.	2.1			
1	50501			
2	50503			
3	50504			
4	50598			
5	50551			
6	50580			
7	50506			
8	50510			
9	50511			
10	50519			
11	50561			
12	50513			
13	50520			
14	50531			
15	-			
16	-			
17	50571			
18	-			